

# Quick Reference

## Learning about the printer

### Using the printer control panel

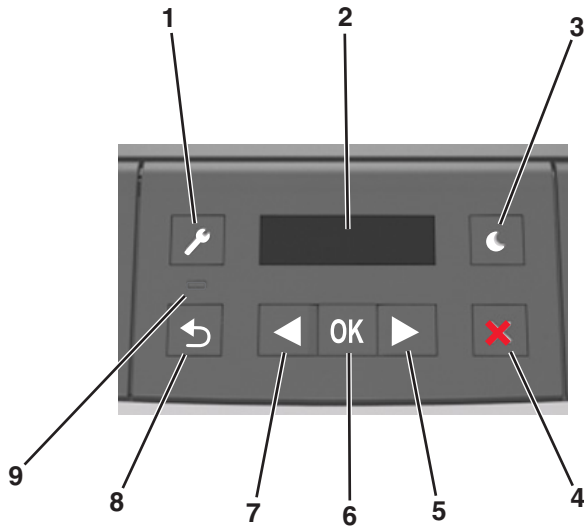

	Use the	To
1	Menus button	Open the menus. <b>Notes:</b> <ul style="list-style-type: none"> <li>The menus are available only when the printer is in the Ready state.</li> <li>Pressing the button while navigating within the menus returns the printer control panel to the top-level menu screen.</li> </ul>
2	Display	View printing options as well as status and error messages.

	Use the	To
3	Sleep button	Enable Sleep mode or Hibernate mode. <b>Notes:</b> <ul style="list-style-type: none"> <li>Pressing any hard button will cause the printer to wake from Sleep mode.</li> <li>Pressing the Sleep button or the power switch will cause the printer to wake from Hibernate mode.</li> </ul>
4	Stop button	<ul style="list-style-type: none"> <li>Exit the menus and return to the Ready state.</li> <li>Stop printer activities, such as printing or downloading fonts.</li> </ul>
5	Right arrow button	<ul style="list-style-type: none"> <li>Scroll through menus or to move between screens and menu options.</li> <li>Scroll through settings or text. For menus with numeric values, press and hold an arrow button to scroll through the settings. Release the button when the value you want appears.</li> </ul>
6	Select button	<ul style="list-style-type: none"> <li>Open a menu.</li> <li>Display available values or settings for a menu. The current default setting is indicated by an asterisk (*).</li> <li>Save the displayed value as the new user default setting.</li> </ul>
7	Left arrow button	<ul style="list-style-type: none"> <li>Scroll through menus or to move between screens and menu options.</li> <li>Scroll through settings or text. For menus with numeric values, press and hold an arrow button to scroll through the settings. Release the button when the value you want appears.</li> </ul>
8	Back button	Return to the previous screen.
9	Indicator light	Determine the status of the printer.

### Understanding the colors of the indicator and Sleep button lights

The colors of the indicator and Sleep button lights on the printer control panel signify a certain printer status or condition.

### Indicator light color and its corresponding printer status

Indicator light	Printer status
Off	The printer is off or in Hibernate mode.
Blinking green	The printer is warming up, processing data, or printing.
Solid green	The printer is on, but idle.
Blinking red	The printer requires user intervention.

### Sleep button light color and its corresponding printer status

Sleep button light	Printer status
Off	The printer is off, idle or in Ready state.
Solid amber	The printer is in Sleep mode.
Blinking amber	The printer is entering or waking from Hibernate mode.
Blinking amber for 0.1 second, then goes completely off for 1.9 seconds in a slow, pulsing pattern	The printer is in Hibernate mode.

## Loading paper and specialty media

### Setting the paper size and type

1 From the printer control panel, navigate to:



2 Select Tray [x] Size or Tray [x] Type, and then press OK.

3 Change the paper size or type setting, and then press OK.

**Notes:**

- The paper size setting for the standard 250-sheet tray (Tray 1), optional 250- or 550-sheet tray (Tray 2), and the multipurpose feeder must be set manually in the Paper Size menu.

- The factory default paper type for Tray 1 is Plain Paper.
- The factory default paper type for the multipurpose feeder is Custom Type 6.
- The paper type setting must be manually set for all trays.





## Configuring Universal paper settings

The Universal paper size is a user-defined setting that lets you print on paper sizes that are not preset in the printer menus.

### Notes:

- The largest supported Universal size is 216 x 355.6 mm (8.5 x 14 inches).
- The smallest Universal size supported in the multipurpose feeder is 76 x 127 mm (3 x 5 inches). The smallest Universal size supported in the optional tray is 183 x 210 mm (7.2 x 8.3 inches).

From the printer control panel, navigate to:

 > Paper Menu >  > Universal Setup >  > Units of Measure >  > select the unit of measure > 

### Specify the paper height and width

1 From the printer control panel, navigate to:

 > Paper Menu >  > Universal Setup >  > Units of Measure >  > select the unit of measure > 

2 Press the arrow buttons until **Portrait Height** or **Portrait Width** appears, and then press .

3 Change the settings, and then press .

## Loading trays

 **CAUTION—POTENTIAL INJURY:** To reduce the risk of equipment instability, load each tray separately. Keep all other trays closed until needed.

1 Pull out the tray completely.

**Note:** Do not remove trays while a job prints or while **Busy** appears on the printer display. Doing so may cause a jam.



2 Squeeze and then slide the width guide tab to the correct position for the size of the paper you are loading.

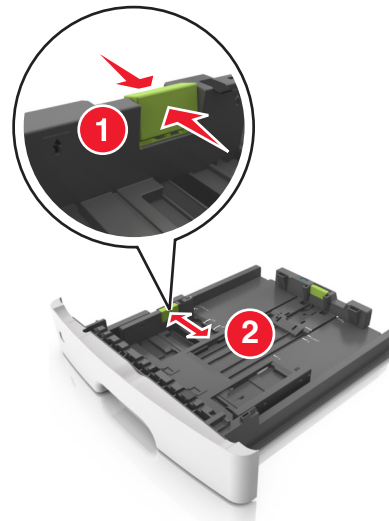

3 Squeeze and then slide the length guide tab to the correct position for the size of the paper you are loading.

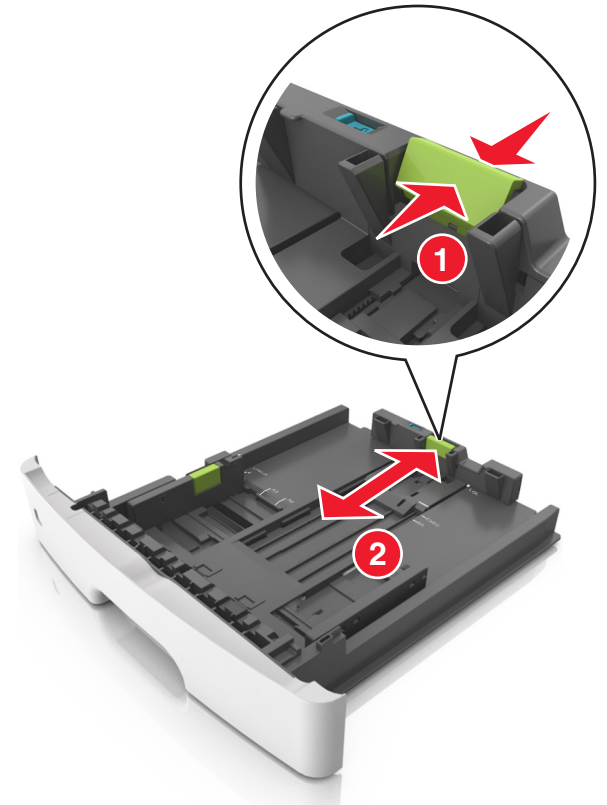

### Notes:

- For some paper sizes like letter, legal, and A4, squeeze and slide the length guide tab backward to accommodate their length.
- When loading legal-size paper, the length guide extends beyond the base leaving the paper exposed to dust. To protect the paper from dust, you can purchase a dust cover separately. For more information, contact customer support.
- If you are loading A6-size paper in the standard tray, then squeeze and then slide the length guide tab toward the center of the tray to the A6-size position.
- Make sure the width and length guides are aligned with the paper size indicators on the bottom of the tray.

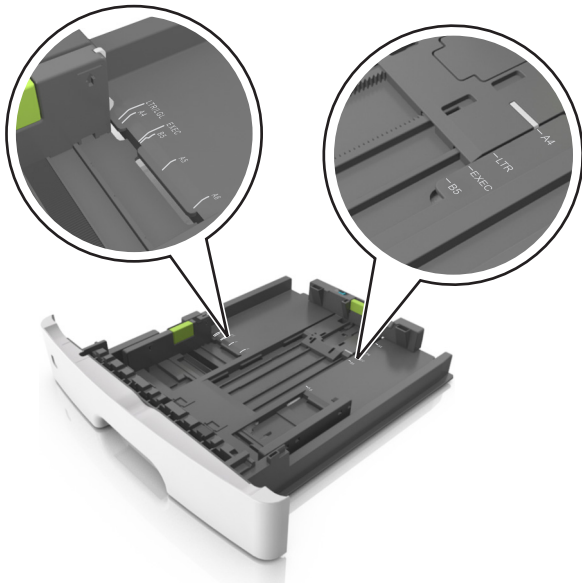

**4** Flex the sheets back and forth to loosen them, and then fan them. Do not fold or crease the paper. Straighten the edges on a level surface.

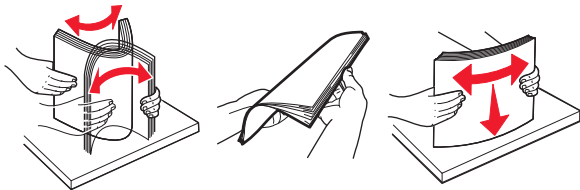

**5** Load the paper stack.



**Notes:**

- Load with the printable side facedown when using recycled or preprinted paper.
- Load prepunched paper with the holes on the top edge toward the front of the tray.
- Load letterhead facedown, with the top edge of the sheet toward the front of the tray. For two-sided printing, load letterhead faceup with the bottom edge of the sheet toward the front of the tray.
- Make sure the paper is below the maximum paper fill indicator located on the side of the width guide.

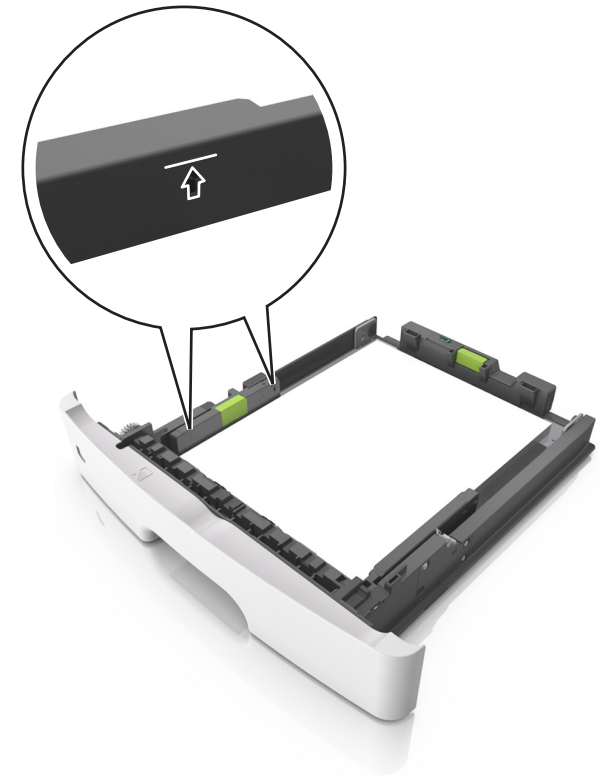

**6** Insert the tray.



- 7 From the printer control panel, set the paper size and paper type in the Paper menu to match the paper loaded in the tray.

**Note:** Set the correct paper size and type to avoid paper jams and print quality problems.

## Loading the multipurpose feeder

Use the multipurpose feeder when printing on different paper sizes and types or specialty media, such as card stock, transparencies, and envelopes. You can also use it for single-page print jobs on letterhead.

- 1 Open the multipurpose feeder.

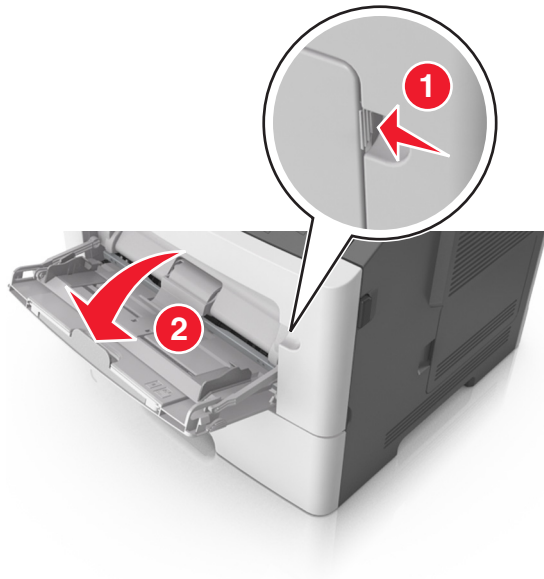

- a Pull the multipurpose feeder extender.



- b Pull the extender gently so that the multipurpose feeder is fully extended and open.



- 2 Squeeze the tab on the left width guide, and then move the guides for the paper you are loading.

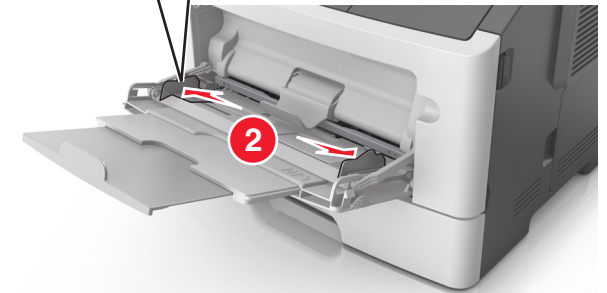

- 3 Prepare the paper or specialty media for loading.

- Flex sheets of paper back and forth to loosen them, and then fan them. Do not fold or crease the paper. Straighten the edges on a level surface.

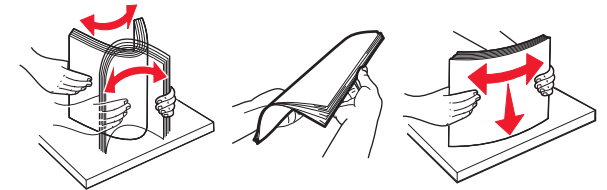

- Hold transparencies by the edges. Flex the stack of transparencies back and forth to loosen them, and then fan them. Straighten the edges on a level surface.

**Note:** Avoid touching the printable side of the transparencies. Be careful not to scratch them.

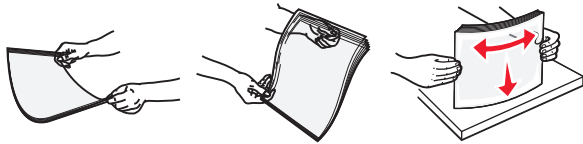

- Flex the stack of envelopes back and forth to loosen them, and then fan them. Straighten the edges on a level surface.



#### 4 Load the paper or specialty media.

##### Notes:

- Do not force paper or specialty media into the multipurpose feeder.
- Make sure the paper or specialty media is below the maximum paper fill indicator located on the paper guides. Overfilling may cause paper jams.

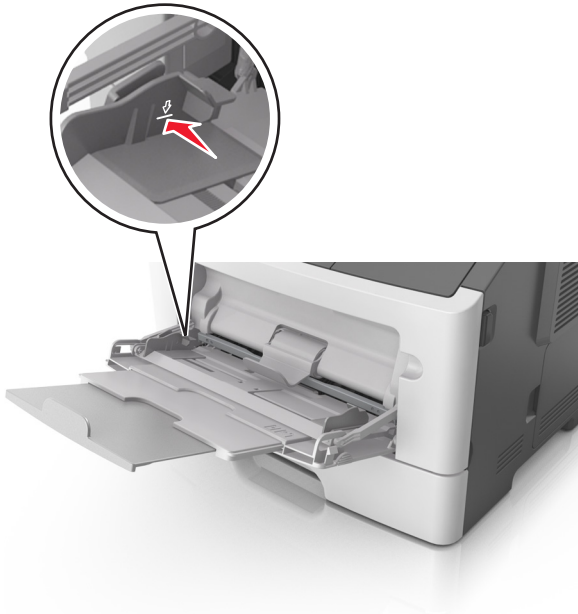

- Load paper, transparencies, and card stock with the recommended printable side faceup and the top edge entering the printer first. For more information on loading

transparencies, see the packaging that the transparencies came in.



**Note:** When loading A6-size paper, make sure the multipurpose feeder extender rests lightly against the edge of the paper so that the last few sheets of paper remain in place.

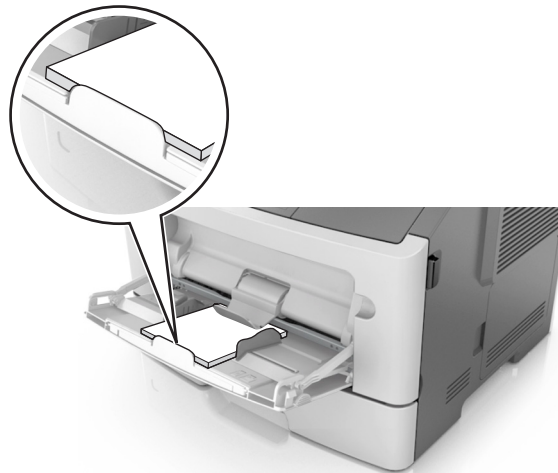

- Load letterhead faceup with the top edge entering the printer first. For two-sided (duplex) printing, load letterhead facedown with the bottom edge entering the printer first.



- Load envelopes with the flap on the left side facedown.

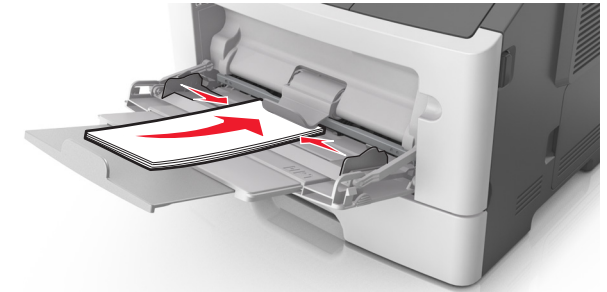

**Warning—Potential Damage:** Never use envelopes with stamps, clasps, snaps, windows, coated linings, or self-stick adhesives. These envelopes may severely damage the printer.

- 5 From the printer control panel, set the paper size and paper type in the Paper menu to match the paper or specialty media loaded in the multipurpose feeder.

## Linking and unlinking trays

### Linking and unlinking trays

#### Using the Embedded Web Server

- 1 Open a Web browser, and then type the printer IP address in the address field.

##### Notes:

- View the printer IP address in the TCP/IP section in the Network/Ports menu. The IP address appears as four sets of numbers separated by periods, such as 123.123.123.123.
- If you are using a proxy server, then temporarily disable it to load the Web page correctly.

- 2 Click **Settings > Paper Menu**.

- 3 Change the tray settings to specify the paper size and type for the tray.

- To link trays, make sure the paper size and type for the tray match with that of the other tray.
- To unlink trays, make sure the paper size or type for the tray does *not* match with that of the other tray.

- 4 Click **Submit**.

#### Using the printer settings on the computer

Depending on your operating system, access the Paper menu using the Local Printer Settings Utility or Printer Settings.

**Note:** You can also specify the paper size and type for the tray using the printer control panel. For more information, see “Setting the paper size and type” on page 1.

**Warning—Potential Damage:** Paper loaded in the tray should match the paper type name assigned in the printer. The temperature of the fuser varies according to the specified paper type. Printing issues may occur if settings are not properly configured.

## Configuring a custom paper type name

#### Using the Embedded Web Server

- 1 Open a Web browser, and then type the printer IP address in the address field.

##### Notes:

- Print a network setup page or menu settings page, and then locate the IP address in the TCP/IP section. The IP address

appears as four sets of numbers separated by periods, such as 123.123.123.123.

- If you are using a proxy server, then temporarily disable it to load the Web page correctly.

- 2 Click **Settings > Paper Menu > Custom Names**.

- 3 Select a custom name, and then type a new custom paper type name.

- 4 Click **Submit**.

- 5 Click **Custom Types**, and then verify if the new custom paper type name has replaced the custom name.

#### Using the printer settings on the computer (Windows only)

Access the Custom menu using the Local Printer Settings Utility.

## Configuring a custom paper type

#### Using the Embedded Web Server

- 1 Open a Web browser, and then type the printer IP address in the address field.

##### Notes:

- Print a network setup page or menu settings page, and then locate the IP address in TCP/IP section. The IP address appears as four sets of numbers separated by periods, such as 123.123.123.123.
- If you are using a proxy server, then temporarily disable it to load the Web page correctly.

- 2 Click **Settings > Paper Menu > Custom Types**.

- 3 Select a custom paper type name, and then select a custom paper type.

**Note:** Plain Paper is the factory default paper type for all user-defined custom names.

- 4 Click **Submit**.

#### Using the printer settings on the computer

Depending on your operating system, access the Custom menu using the Local Printer Settings Utility or Printer Settings.

## Assigning a custom paper type

#### Using the Embedded Web Server

- 1 Open a Web browser, and then type the printer IP address in the address field.

##### Notes:

- Print a network setup page or menu settings page, and then locate the IP address in the TCP/IP section. The IP address appears as four sets of numbers separated by periods, such as 123.123.123.123.

- If you are using a proxy server, then temporarily disable it to load the Web page correctly.

- 2 Click **Settings > Paper Menu**.

- 3 From the Tray Configuration section, select a paper source, and then select a custom paper type under the paper type column.

- 4 Click **Submit**.

#### Using the printer settings on the computer

Depending on your operating system, access the Paper menu using the Local Printer Settings Utility or Printer Settings.

## Printing

### Printing a document

#### Printing a document

- 1 From the Paper menu on the printer control panel, set the paper type and size to match the paper loaded.

- 2 Send the print job:

##### For Windows users

- a With a document open, click **File > Print**.
- b Click **Properties, Preferences, Options, or Setup**.
- c Adjust the settings, if necessary.
- d Click **OK > Print**.

##### For Macintosh users

- a Customize the settings in the Page Setup dialog:
  - 1 With a document open, choose **File > Page Setup**.
  - 2 Choose a paper size or create a custom size to match the paper loaded.
  - 3 Click **OK**.
- b Customize the settings in the Print dialog:
  - 1 With a document open, choose **File > Print**. If necessary, click the disclosure triangle to see more options.

- From the Print dialog and pop-up menus, adjust the settings if necessary.

**Note:** To print on a specific paper type, adjust the paper type setting to match the paper loaded, or select the appropriate tray or feeder.

- Click **Print**.

## Adjusting toner darkness

### Using the Embedded Web Server

- Open a Web browser, and then type the printer IP address in the address field.

#### Notes:

- View the printer IP address in the TCP/IP section in the Network/Ports menu. The IP address appears as four sets of numbers separated by periods, such as 123.123.123.123.
- If you are using a proxy server, then temporarily disable it to load the Web page correctly.

- Click **Settings > Print Settings > Quality Menu > Toner Darkness**.
- Adjust the toner darkness setting.
- Click **Submit**.

### Using the printer settings on the computer

Depending on your operating system, adjust the toner darkness settings using the Local Printer Settings Utility or Printer Settings.

#### Using the printer control panel

- From the printer control panel, navigate to:



- Adjust the toner darkness.

- Press **OK**.

## Printing information pages

### Printing a font sample list

From the printer control panel, navigate to either of the following:



or



### Printing a menu settings page

Print a menu settings page to review the current menu settings and to verify if the printer options are installed correctly.

**Note:** If you have not changed any menu settings, then the menu settings page lists all the factory default settings. When you select and save other settings from the menus, they replace the factory default settings as *user default settings*. A user default setting remains in effect until you access the menu again, choose another value, and save it.

From the printer control panel, navigate to:



### Printing a network setup page

If the printer is connected to a network, then print a network setup page to verify the network connection. This page also provides important information that aids network printing configuration.

- From the printer control panel, navigate to:



**Note:** If an optional print server is installed, then **Print Network [x] Setup Page** appears.

- Check the first section of the network setup page and confirm that the status is Connected.

If the status is Not Connected, then the LAN drop may not be active, or the network cable may be malfunctioning. Consult your system support person for a solution, and then print another network setup page.

## Canceling a print job

### Canceling a print job from the printer control panel

From the printer control panel, press **Cancel** > **OK**.

### Canceling a print job from the computer

#### For Windows users

- Open the printers folder.

##### In Windows 8

From the Search charm, type **run**, and then navigate to:  
Apps list > **Run** > type **control printers** > **OK**

##### In Windows 7 or earlier

- Click  or click **Start**, and then click **Run**.
- In the Start Search or Run dialog, type **control printers**.
- Press **Enter**, or click **OK**.

- Double-click the printer icon.

- Select the print job you want to cancel.

- Click **Delete**.

#### For Macintosh users

- From the Apple menu, navigate to either of the following:
  - System Preferences > Print & Scan** > select your printer > **Open Print Queue**
  - System Preferences > Print & Fax** > select your printer > **Open Print Queue**
- From the printer window, select the print job you want to cancel, and then delete it.

# Clearing jams

## Understanding jam messages and locations

When a jam occurs, a message indicating the jam location and information to clear the jam appears on the printer display. Open the doors, covers, and trays indicated on the display to remove the jam.

### Notes:

- When Jam Assist is set to On, the printer automatically flushes blank pages or pages with partial prints to the standard bin after a jammed page has been cleared. Check your printed output stack for discarded pages.
- When Jam Recovery is set to On or Auto, the printer reprints jammed pages. However, the Auto setting does not guarantee that the page will print.

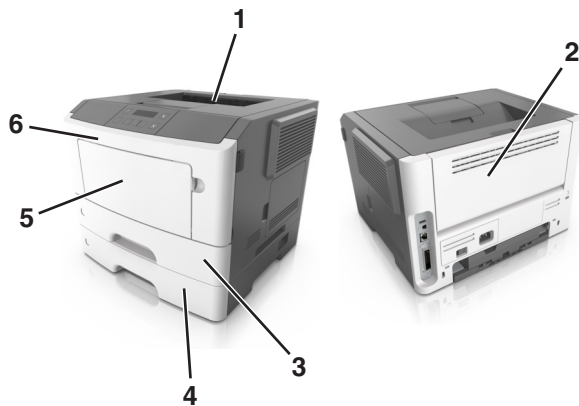

	Area	Printer control panel message	What to do
1	Standard bin	Jam, standard bin [20y.xx]	Remove the jammed paper.
2	Rear door	Jam, rear door [20y.xx]	Open the rear door, and then remove the jammed paper.

	Area	Printer control panel message	What to do
3	Tray 1	Jam, pull tray 1. Push down blue flap. [23y.xx]	Pull tray 1 completely out, then push the front duplex flap down, and then remove the jammed paper. <b>Note:</b> You may need to open the rear door to clear some 23y.xx paper jams.
4	Tray [x]	Jam, tray [x] [24y.xx]	Pull the indicated tray out, and then remove the jammed paper.
5	Multipurpose feeder	Jam, MP feeder. [250.xx]	Remove all paper from the multipurpose feeder, and then remove the jammed paper.
6	Front door	Jam, front door. [20y.xx]	Open the front door, and then remove the toner cartridge, imaging unit, and jammed paper.

### Jam, front door [20y.xx]

**CAUTION—HOT SURFACE:** The inside of the printer might be hot. To reduce the risk of injury from a hot component, allow the surface to cool before touching it.

- 1 Press the button on the right side of the printer, and then open the front door.

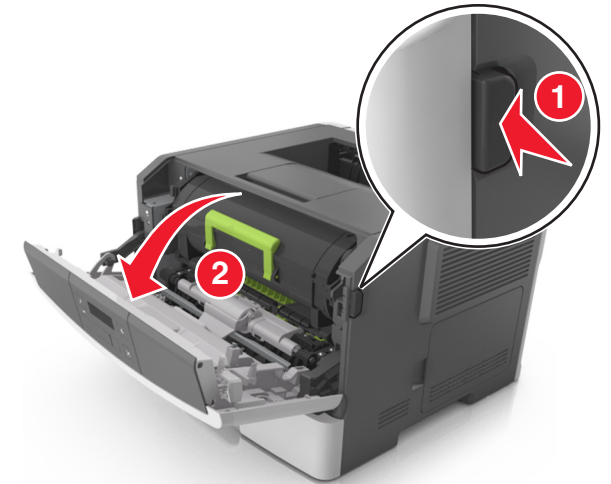

- 2 Pull the toner cartridge out using the handle.

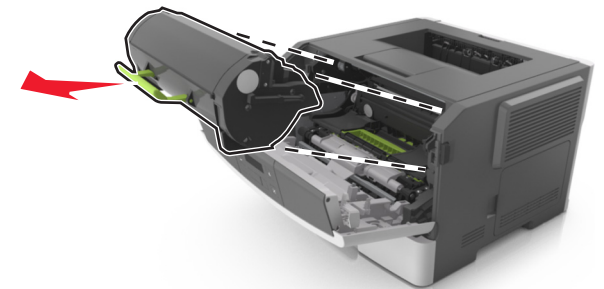



- 3 Lift the green handle, and then pull the imaging unit out of the printer.

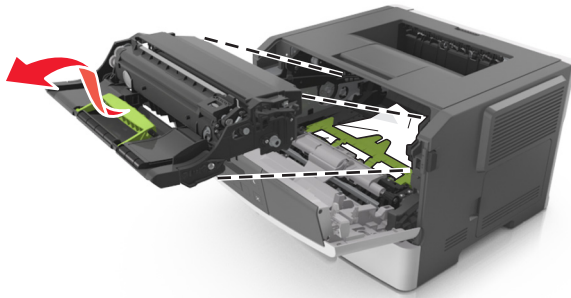

**Warning—Potential Damage:** Do not touch the photoconductor drum. Doing so may affect the print quality of future print jobs.

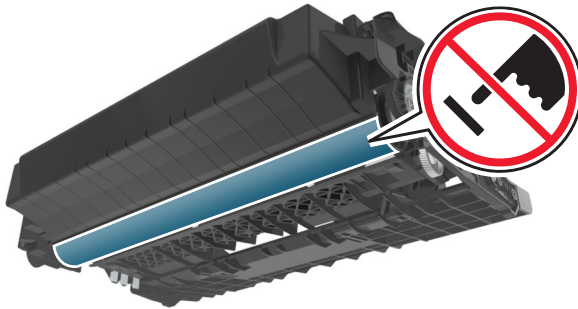

- 4 Place the imaging unit aside on a flat, smooth surface.

**Warning—Potential Damage:** Do not expose the imaging unit to direct light for more than 10 minutes. Extended exposure to light can cause print quality problems.

- 5 Lift the green flap in front of the printer.

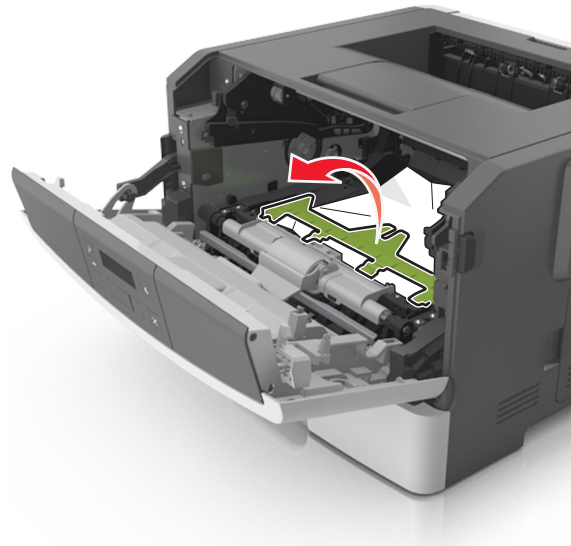

- 6 Firmly grasp the jammed paper on each side, and then gently pull it out.

**Note:** Make sure all paper fragments are removed.

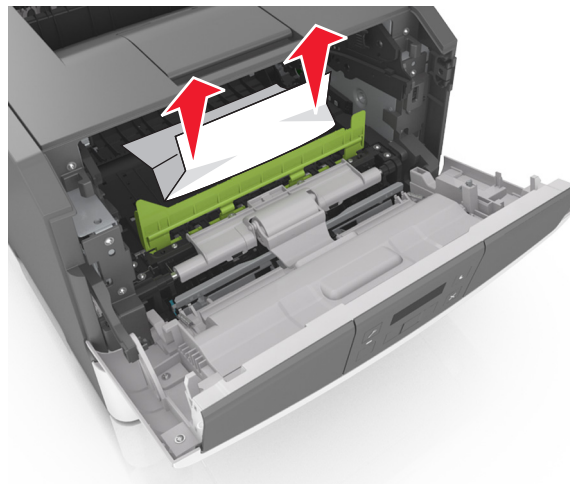

- 7 Insert the imaging unit by aligning the arrows on the side rails of the unit with the arrows on the side rails inside the printer, and then insert the imaging unit into the printer.

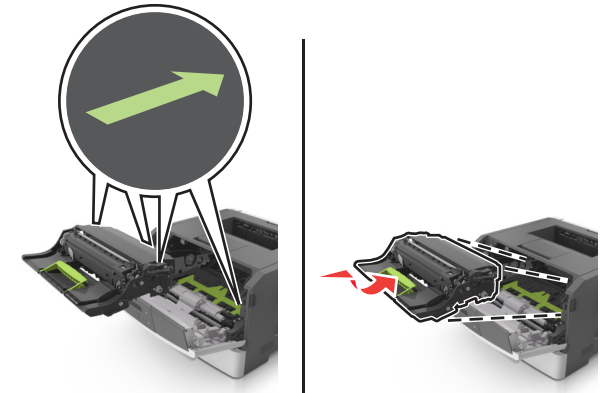

- 8 Insert the toner cartridge by aligning the side rails of the cartridge with the arrows on the side rails inside the printer, and then insert the cartridge into the printer.

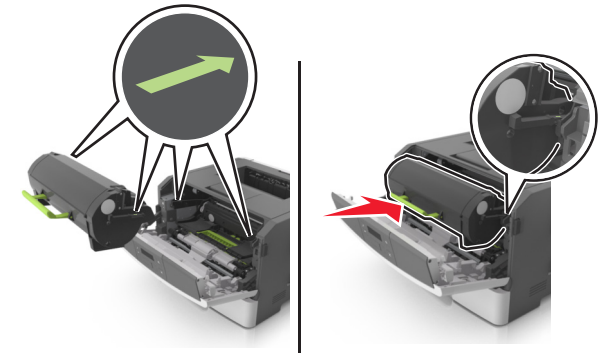

- 9 Close the front door.

- 10 From the printer control panel, press  to clear the message and continue printing.

## Jam, rear door [20y.xx]

- 1 Press the button on the right side of the printer, and then open the front door.

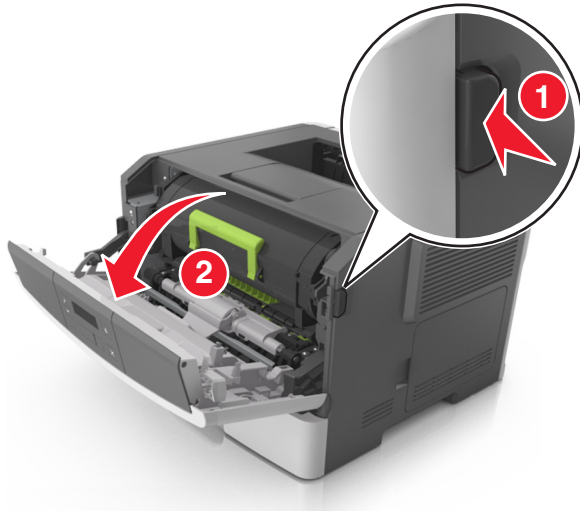

- 2 Gently pull down the rear door.

 **CAUTION—HOT SURFACE:** The inside of the printer might be hot. To reduce the risk of injury from a hot component, allow the surface to cool before touching it.

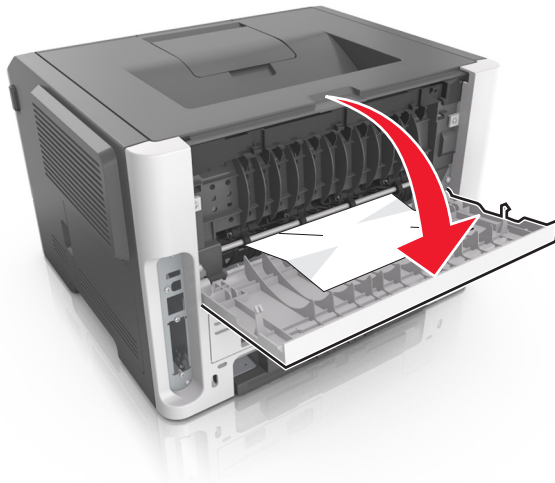

- 3 Firmly grasp the jammed paper on each side, and then gently pull it out.

**Note:** Make sure all paper fragments are removed.

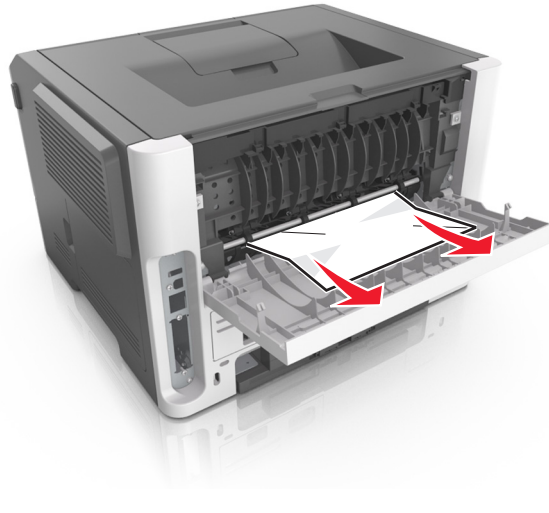

- 4 Close the rear and front doors.

- 5 From the printer control panel, press  to clear the message and continue printing.

## Jam, standard bin [20y.xx]

- 1 Firmly grasp the jammed paper on each side, and then gently pull it out.

**Note:** Make sure all paper fragments are removed.



- 2 From the printer control panel, press  to clear the message and continue printing.

## Jam, pull tray 1. Push down blue flap. [23y.xx]

 **CAUTION—HOT SURFACE:** The inside of the printer might be hot. To reduce the risk of injury from a hot component, allow the surface to cool before touching it.

- 1 Pull the tray out completely.

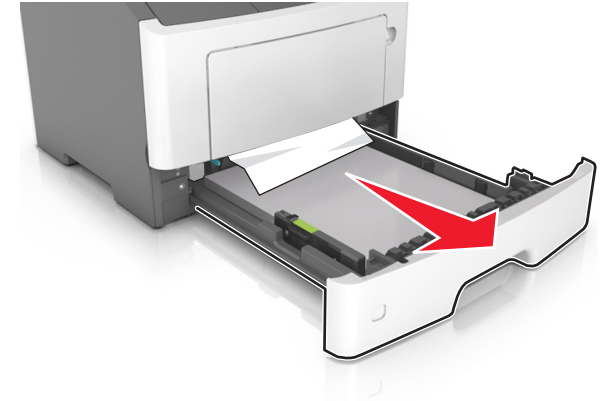

- 2 Locate the blue lever, and then pull it down to release the jam.

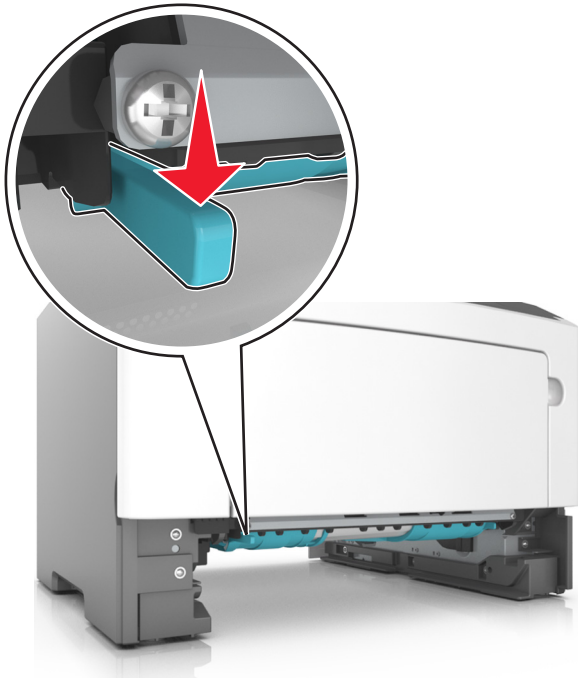

**Note:** If the jammed paper is not visible in the duplex area, then open the rear door, and then gently remove the jammed paper. Make sure all paper fragments are removed.

- 3 Firmly grasp the jammed paper on each side, and then gently pull it out.

**Note:** Make sure all paper fragments are removed.



- 4 Insert the tray.

- 5 From the printer control panel, press  to clear the message and continue printing.

### Jam, tray [x] [24y.xx]

- 1 Pull out the tray completely.

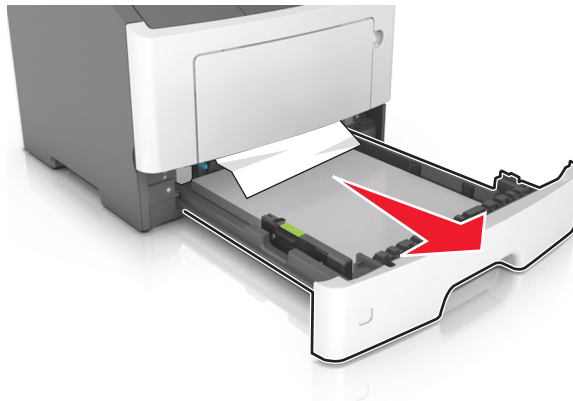

- 2 Firmly grasp the jammed paper on each side, and then gently pull it out.

**Note:** Make sure all paper fragments are removed.

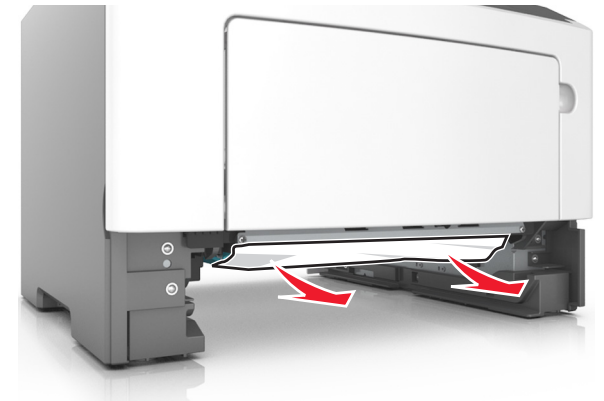

- 3 Insert the tray.

- 4 From the printer control panel, press  to clear the message and continue printing.

### Jam, MP feeder [250.xx]

- 1 From the multipurpose feeder, firmly grasp the jammed paper on each side, and then gently pull it out.

**Note:** Make sure all paper fragments are removed.

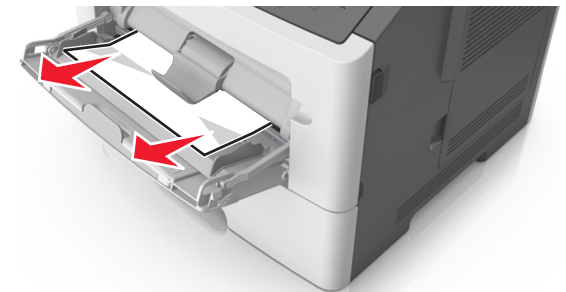

- 2 Flex the sheets of paper back and forth to loosen them, and then fan them. Do not fold or crease the paper. Straighten the edges on a level surface.

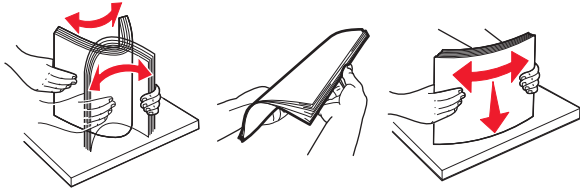

- 3 Reload paper into the multipurpose feeder.

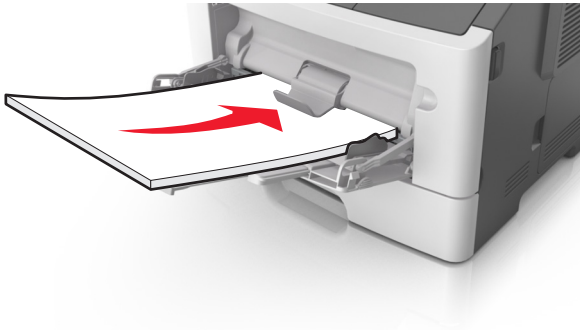

**Note:** Make sure the paper guide lightly rests against the edge of the paper.

- 4 From the printer control panel, press  to clear the message and continue printing.